

FRONT ELEVATION

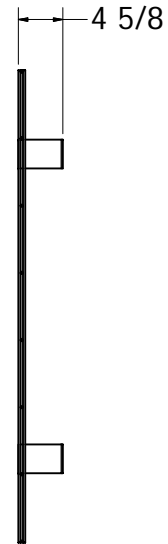

SIDE ELEVATION

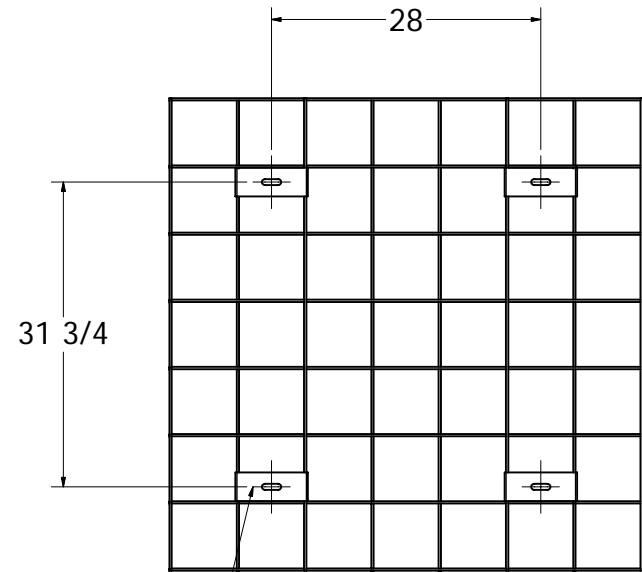

REAR ELEVATION

Mounting Bracket (4)

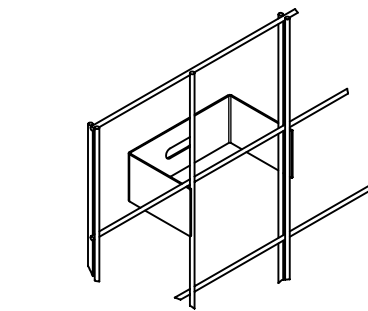
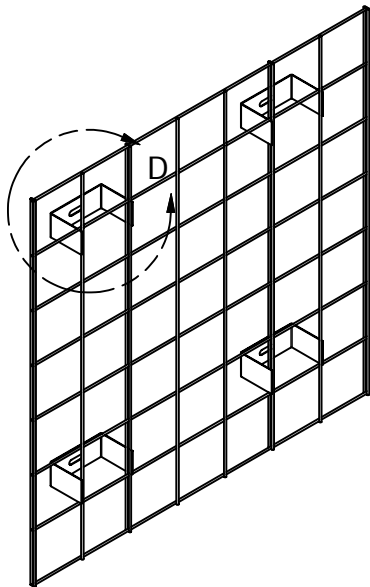

MOUNTING BRACKET DETAILS

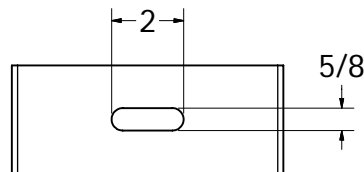

Finish: The entire assembly is powder coated
Gloss Black

DRAWN Rudy Galindo	1/28/2009	 Tournesol Siteworks 42326 Albrae Street, Fremont, CA 94538 (800) 542-2282	TITLE
CHECKED			TW-4848-AD
QA		SIZE C	DWG NO TW-4848-AD
MFG		SCALE	REV
APPROVED		SHEET 1 OF 2	

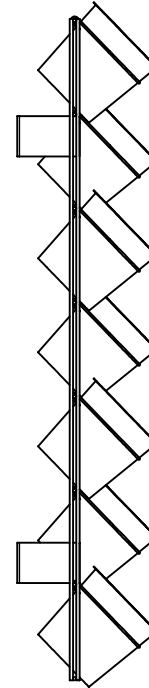
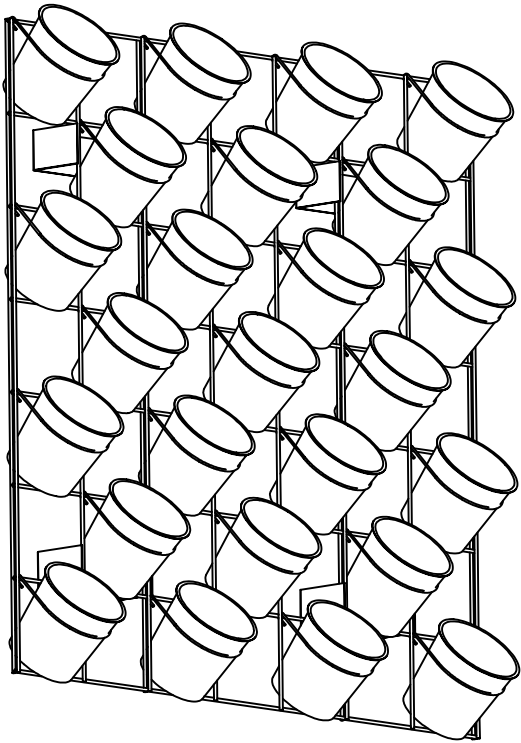

Typical Cachepot Spacing
25 Cachepots typical

DRAWN Rudy Galindo	1/28/2009	 Tournesol Siteworks 42326 Albrae Street, Fremont, CA 94538 (800) 542-2282	TITLE	
CHECKED			TW-4848-AD	
QA		SIZE C		
MFG				
APPROVED		DWG NO		REV
		TW-4848-AD		
		SCALE		SHEET 2 OF 2